

# 300/500mA Low Dropout Linear Voltage Regulator

## General Description

The RT9161/A is a 300/500mA fixed output voltage low dropout linear regulator. Typical ground current is approximately 110µA, from zero to maximum loading conditions. Wide range of available output voltage fits most of applications. Built-in output current-limiting most thermal-limiting provide maximal protection against any fault conditions.

For ease of application, the RT9161/A comes in the popular 3-pin SOT-23 (300mA), SOT-89 (300mA), SOT-223 (500mA), or TO-92 packages.

## Ordering Information

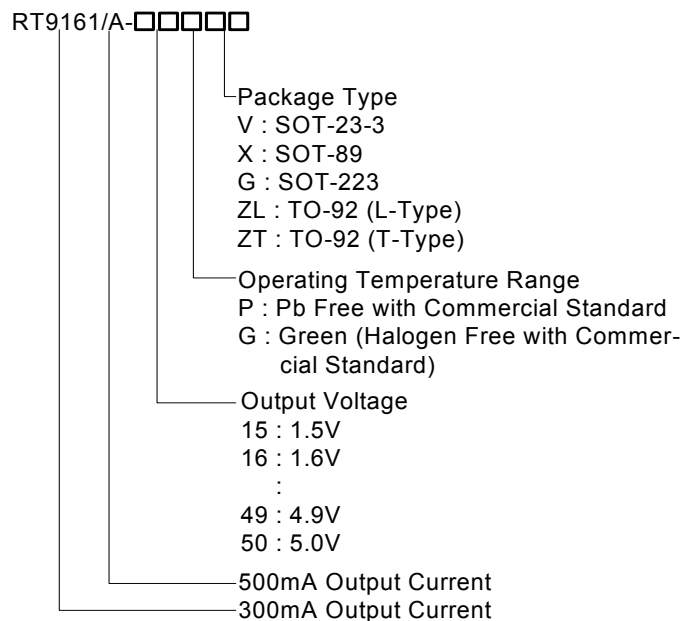

Note :

RichTek Pb-free and Green products are :

- ▶RoHS compliant and compatible with the current requirements of IPC/JEDEC J-STD-020.
- ▶Suitable for use in SnPb or Pb-free soldering processes.
- ▶100%matte tin (Sn) plating.

## Features

- Low Dropout Voltage of 200mV at Output Current 100mA, 450mV at Output Current 300mA, and 750mV at 500mA Output Current
- Guaranteed 300/500mA Output Current
- Internal 1.5Ω P-MOSFET Draws No Base Current
- Low Ground Current 110µA
- 2% Accuracy Output Voltage
- Input Voltage Range up to 12V
- Extremely Tight Load Regulation
- Fast Transient Response
- Current-limiting and Thermal-limiting
- RoHS Compliant and 100% Lead (Pb)-Free

## Applications

- Voltage Regulator for LAN Card, CD-ROM, and DVD
- Wireless Communication Systems
- Battery Powered Systems

## Marking Information

For marking information, contact our sales representative directly or through a RichTek distributor located in your area, otherwise visit our website for detail.

## Pin Configurations

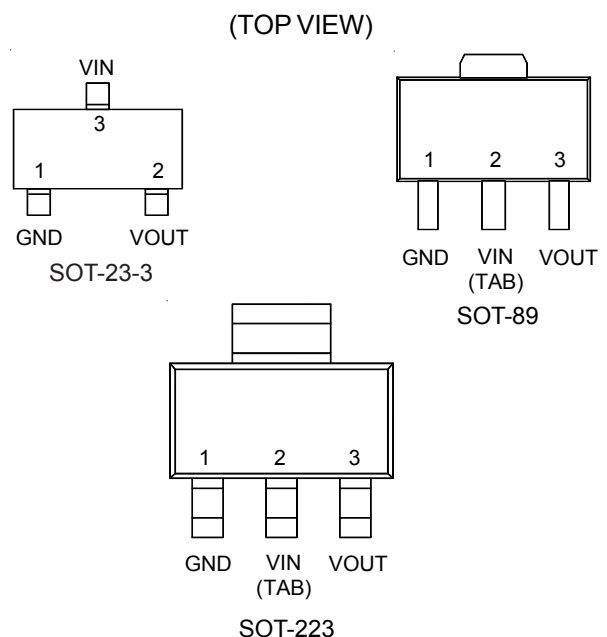

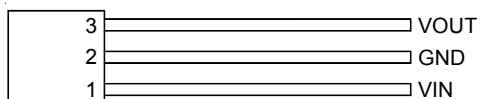

TO-92  
RT9161/A-□□CZL

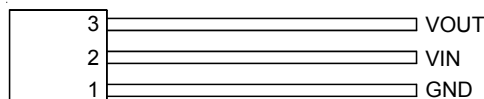

TO-92  
RT9161/A-□□CZT

## Typical Application Circuit

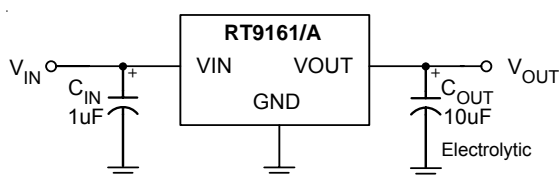

## Functional Pin Description

Pin Name	Pin Function
VOUT	Output Voltage
GND	Ground
VIN	Power Input

## Function Block Diagram

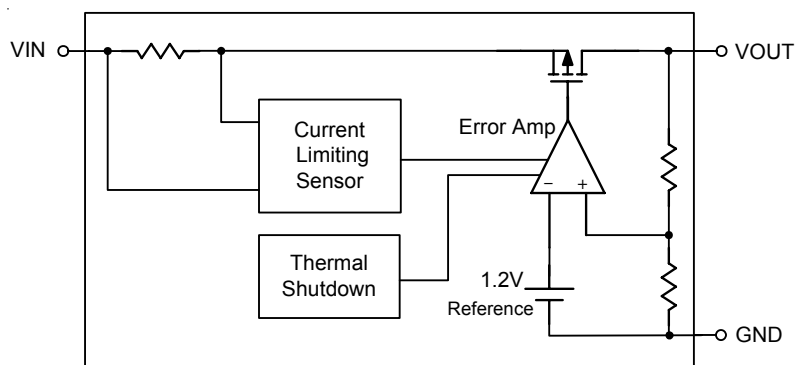

**Absolute Maximum Ratings**

- Input Voltage ----- -0.3 to 14V
- Operating Junction Temperature Range ----- -40°C to 125°C
- Storage Temperature Range ----- -65°C to 150°C
- Power Dissipation, P<sub>D</sub> @ T<sub>A</sub> = 25°C
  - SOT-23-3 ----- 0.4W
  - SOT-89 ----- 0.571W
  - SOT-223 ----- 0.741W
  - TO-92 ----- 0.625W
- Package Thermal Resistance (Note 4)
  - SOT-23-3, θ<sub>JA</sub> ----- 250°C/W
  - SOT-23-3, θ<sub>JC</sub> ----- 140°C/W
  - SOT-89, θ<sub>JA</sub> ----- 175°C/W
  - SOT-89, θ<sub>JC</sub> ----- 100°C/W
  - SOT-223, θ<sub>JA</sub> ----- 135°C/W
  - SOT-223, θ<sub>JC</sub> ----- 15°C/W
  - TO-92, θ<sub>JA</sub> ----- 160°C/W
  - TO-92, θ<sub>JC</sub> ----- 125°C/W

**Electrical Characteristics**

(T<sub>A</sub> = 25°C, C<sub>IN</sub> = 1μF, C<sub>OUT</sub> = 10μF, unless otherwise specified.)

Parameter	Symbol	Test Conditions	Min	Typ	Max	Units
Output Voltage Accuracy	ΔV <sub>OUT</sub>	I <sub>L</sub> = 1mA, V <sub>IN</sub> = 5V	-2	--	+2	%
Output Voltage Temperature Coefficient			--	50	150	PPM/°C
Line Regulation	ΔV <sub>LINE</sub>	I <sub>L</sub> = 1mA, V <sub>IN</sub> = 4.5 ~ 12V	--	2	3	%V <sub>OUT</sub>
Load Regulation (Note1)	ΔV <sub>LOAD</sub>	I <sub>L</sub> = 1mA ~ 300/500mA, V <sub>IN</sub> = 5V	--	1	30/50	mV
Current Limit (Note 2)	RT9161	I <sub>LIM</sub> V <sub>IN</sub> = 5V, V <sub>OUT</sub> = 0V	350	580	--	mA
	RT9161A		500	900	--	
Dropout Voltage (Note 3)	V <sub>DROP</sub>	I <sub>L</sub> = 300/500mA	--	450/750	600/1000	mV
Standby Current	I <sub>STANDBY</sub>	I <sub>L</sub> = 0, V <sub>IN</sub> = 12V	--	110	180	μA

**Note 1.** Regulation is measured at constant junction temperature, using pulsed ON time.

**Note 2.** Current Limit is measured at constant junction temperature, using pulsed ON time.

**Note 3.** The dropout voltage is defined as V<sub>IN</sub> -V<sub>OUT</sub>, which is measured when V<sub>OUT</sub> is V<sub>OUT(NORMAL)</sub> - 100mV.

**Note 4.** θ<sub>JA</sub> is measured in the natural convection at T<sub>A</sub> = 25°C on a low effective single layer thermal conductivity test board of JEDEC 51-3 thermal measurement standard.

Typical Operating Characteristics

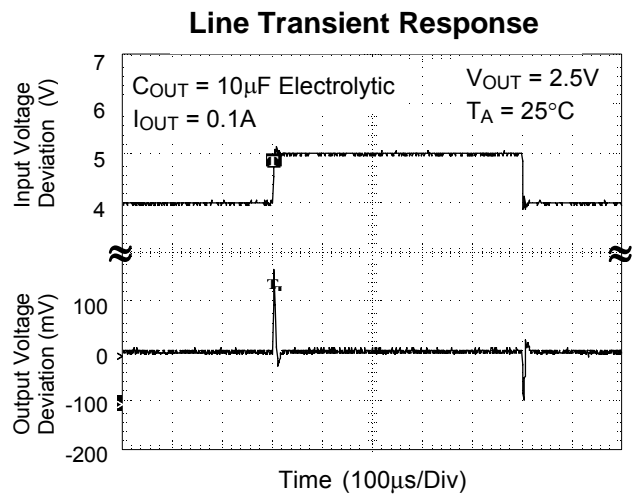
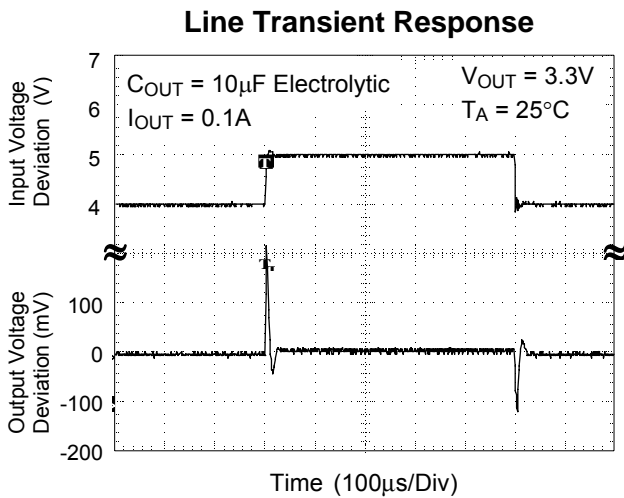
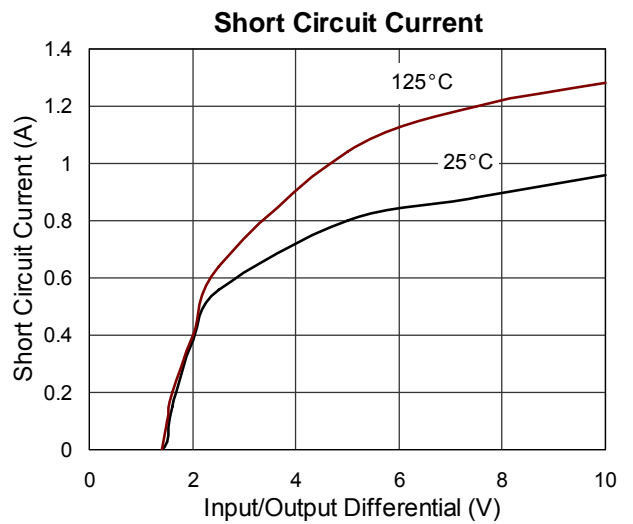
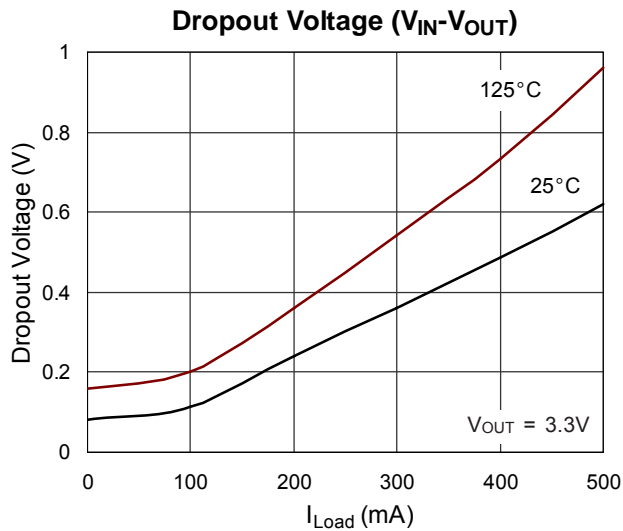
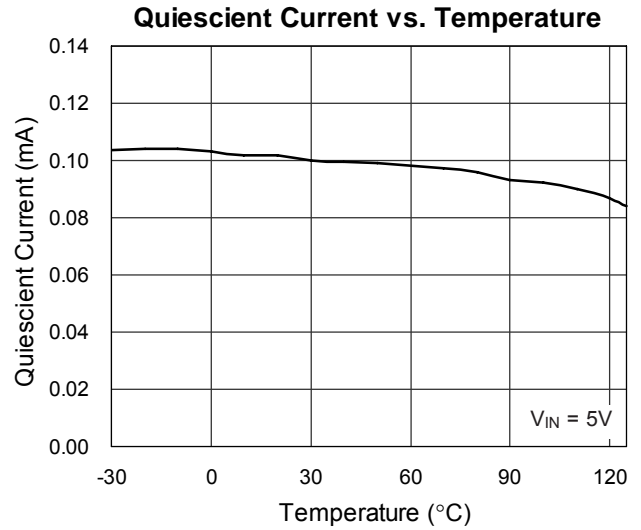
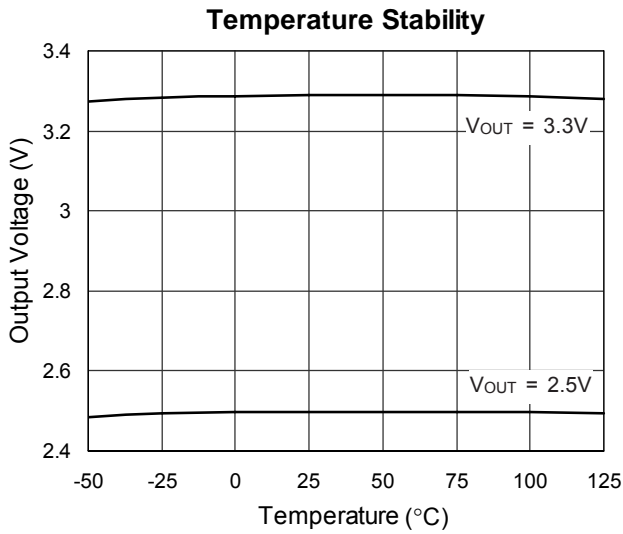

Load Transient Response

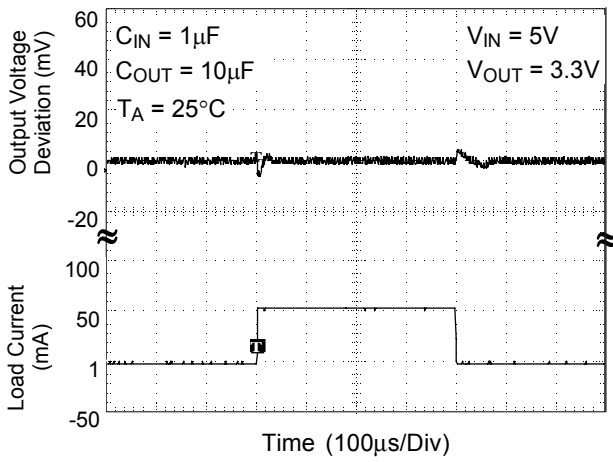

Load Transient Response

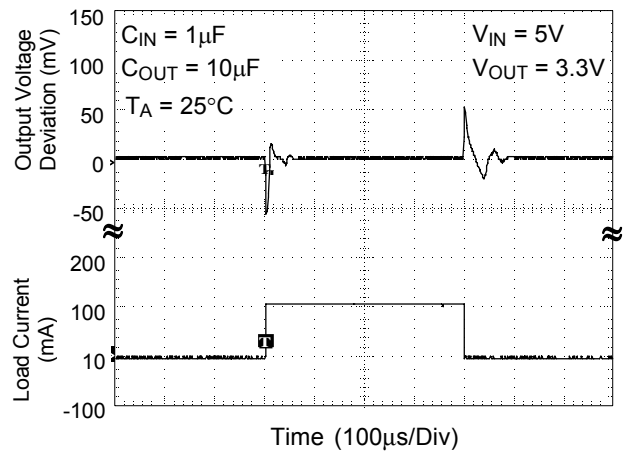

Load Transient Response

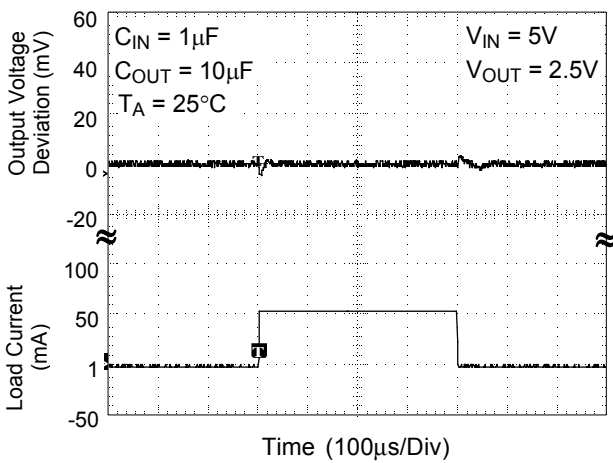

Load Transient Response

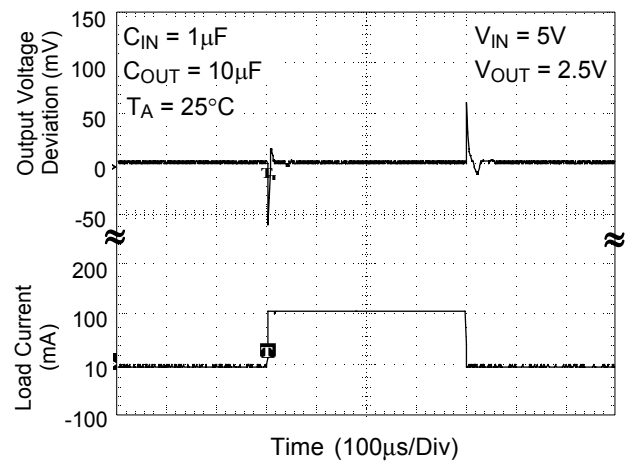

PSRR

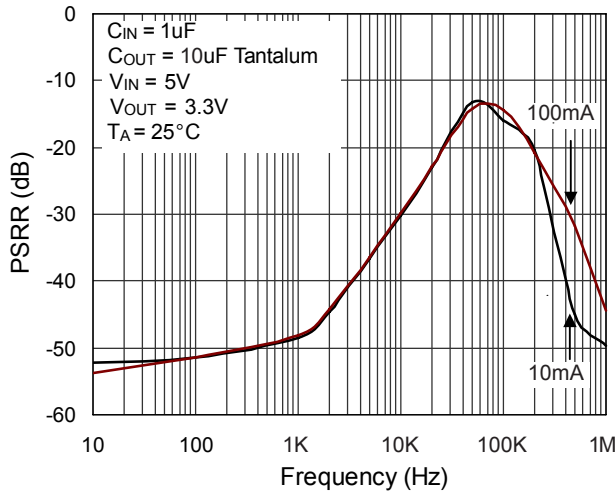

PSRR

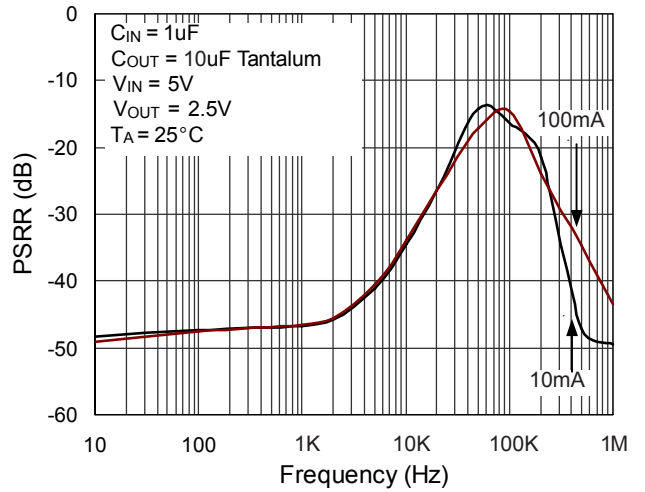

**Application Information**

A 10uF capacitor with 200mΩ or higher ESR, connecting between VOUT and GND pins, is recommended for stability. A capacitor with ESR smaller than 200 mΩ may cause VOUT oscillation as shown in Figure 1. Operating temperature should be well considered to ensure that the capacitance is no less than 10uF over the operating temperature range. Please take the notice that Aluminum electrolytic capacitors may cause VOUT oscillation when operating below -25°C. The capacitance can be increased without limit for better transient response.

A 1uF or higher capacitor should be placed between VIN and GND to filter out input noise and ensure stable output voltage.

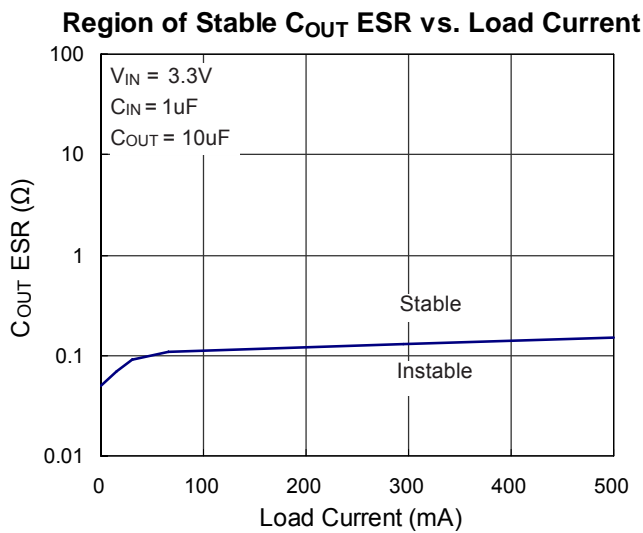

Figure 1

Thermal protection limits power dissipation in RT9161/A. When the operation junction temperature exceeds 165°C, the OTP circuit starts the thermal shutdown function and turns the pass element off. The pass element turn on again after the junction temperature cools by 30°C.

For continuous operation, do not exceed absolute maximum operation junction temperature 125°C. The power dissipation definition in device is:

$$P_D = (V_{IN} - V_{OUT}) \times I_{OUT} + V_{IN} \times I_Q$$

The maximum power dissipation depends on the thermal resistance of IC package, PCB layout, the rate of surroundings airflow and temperature difference between junction to ambient. The maximum power dissipation can be calculated by following formula:

$$P_{D(MAX)} = (T_{J(MAX)} - T_A) / \theta_{JA}$$

Where  $T_{J(MAX)}$  is the maximum operation junction temperature 125°C,  $T_A$  is the ambient temperature and the  $\theta_{JA}$  is the junction to ambient thermal resistance.

For recommended operating conditions specification of RT9161/A, where  $T_{J(MAX)}$  is the maximum junction temperature of the die (125°C) and  $T_A$  is the maximum ambient temperature. The junction to ambient thermal resistance  $\theta_{JA}$  is layout dependent. For SOT-223 packages, the thermal resistance  $\theta_{JA}$  is 135°C/W on the standard JEDEC 51-3 single-layer 1S thermal test board. The maximum power dissipation at  $T_A = 25^\circ\text{C}$  can be calculated by following formula:

$$P_{D(MAX)} = (125^\circ\text{C} - 25^\circ\text{C}) / 250 = 0.400 \text{ W for SOT-23-3 packages}$$

$$P_{D(MAX)} = (125^\circ\text{C} - 25^\circ\text{C}) / 175 = 0.571 \text{ W for SOT-89 packages}$$

$$P_{D(MAX)} = (125^\circ\text{C} - 25^\circ\text{C}) / 135 = 0.741 \text{ W for SOT-223 packages}$$

$$P_{D(MAX)} = (125^\circ\text{C} - 25^\circ\text{C}) / 160 = 0.625 \text{ W for TO-92 packages}$$

The maximum power dissipation depends on operating ambient temperature for fixed  $T_{J(MAX)}$  and thermal resistance  $\theta_{JA}$ . For RT9161/A packages, the Figure 2 of derating curves allows the designer to see the effect of rising ambient temperature on the maximum power allowed.

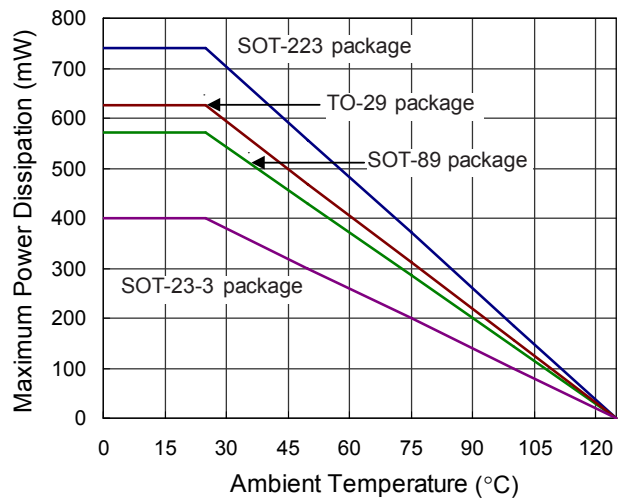
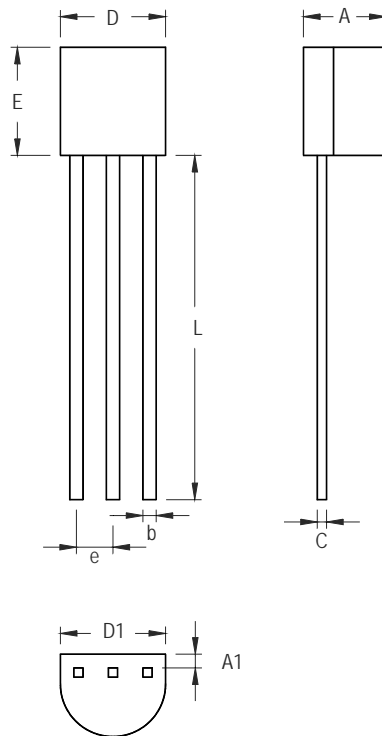

Figure 2. Derating Curves

**Outline Dimension**



Symbol	Dimensions In Millimeters		Dimensions In Inches	
	Min	Max	Min	Max
A	3.175	4.191	0.125	0.165
A1	1.143	1.372	0.045	0.054
b	0.406	0.533	0.016	0.021
C	0.406	0.533	0.016	0.021
D	4.445	5.207	0.175	0.205
D1	3.429	5.029	0.135	0.198
E	4.318	5.334	0.170	0.210
e	1.143	1.397	0.045	0.055
L	12.700		0.500	

**3-Lead TO-92 Plastic Package**

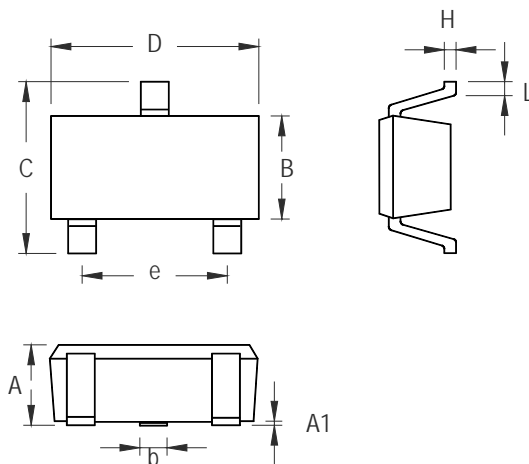

Symbol	Dimensions In Millimeters		Dimensions In Inches	
	Min	Max	Min	Max
A	0.889	1.295	0.035	0.051
A1	0.000	0.152	0.000	0.006
B	1.397	1.803	0.055	0.071
b	0.356	0.508	0.014	0.020
C	2.591	2.997	0.102	0.118
D	2.692	3.099	0.106	0.122
e	1.803	2.007	0.071	0.079
H	0.080	0.254	0.003	0.010
L	0.300	0.610	0.012	0.024

SOT-23-3 Surface Mount Package



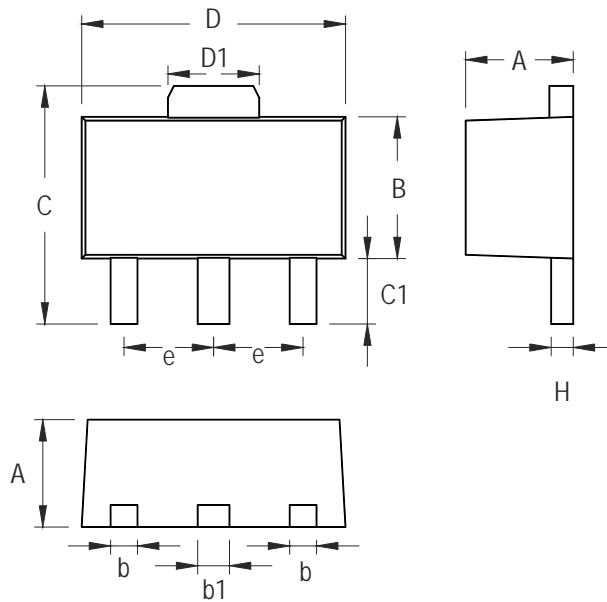

Symbol	Dimensions In Millimeters		Dimensions In Inches	
	Min	Max	Min	Max
A	1.397	1.600	0.055	0.063
b	0.356	0.483	0.014	0.019
B	2.388	2.591	0.094	0.102
b1	0.406	0.533	0.016	0.021
C	3.937	4.242	0.155	0.167
C1	0.787	1.194	0.031	0.047
D	4.394	4.597	0.173	0.181
D1	1.397	1.753	0.055	0.069
e	1.448	1.549	0.057	0.061
H	0.356	0.432	0.014	0.017

**3-Lead SOT-89 Surface Mount Package**

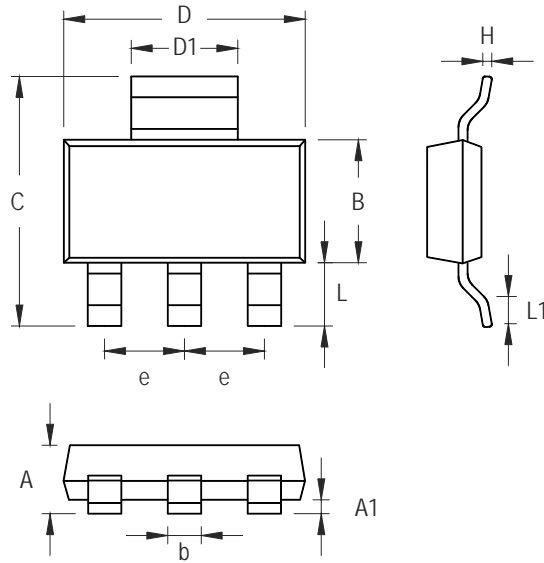

Symbol	Dimensions In Millimeters		Dimensions In Inches	
	Min	Max	Min	Max
A	1.450	1.803	0.057	0.071
A1	0.020	0.100	0.0008	0.0047
b	0.610	0.787	0.024	0.031
B	3.302	3.708	0.130	0.146
C	6.706	7.290	0.264	0.287
D	6.299	6.706	0.248	0.264
D1	2.896	3.150	0.114	0.124
e	2.261	2.362	0.089	0.093
H	0.229	0.330	0.009	0.013
L	1.550	1.950	0.061	0.077
L1	0.800	1.100	0.009	0.013

**3-Lead SOT-223 Surface Mount Package**

**Richtek Technology Corporation**

Headquarter  
 5F, No. 20, Taiyuen Street, Chupei City  
 Hsinchu, Taiwan, R.O.C.  
 Tel: (8863)5526789 Fax: (8863)5526611

**Richtek Technology Corporation**

Taipei Office (Marketing)  
 8F, No. 137, Lane 235, Paochiao Road, Hsintien City  
 Taipei County, Taiwan, R.O.C.  
 Tel: (8862)89191466 Fax: (8862)89191465  
 Email: marketing@richtek.com